



**PIR34**

**Infrared Motion Sensor**



## **INTRODUCTION**

The PIR34 is designed to automatically turn lights on when motion and body heat is detected. The sensor has a 180° detection range with adjustable time and light level, and can be connected to existing lighting installations. The sensor can be installed inside or outside under eaves.

## **Features**

- 180° Wide Angle
- Automatically turn lights on when motion & body heat is detected
- Time delay of 10s, 30s, 90s, 3min & 7min up to 15 minutes ( $\pm 2$ min)
- Wall mounted
- Eco-Friendly when used with energy saving bulb
- The PIR34 detects daylight and darkness and can be set to operate at 3, 30, 300, 2000 LUX levels
- IP44 housing.

## Description

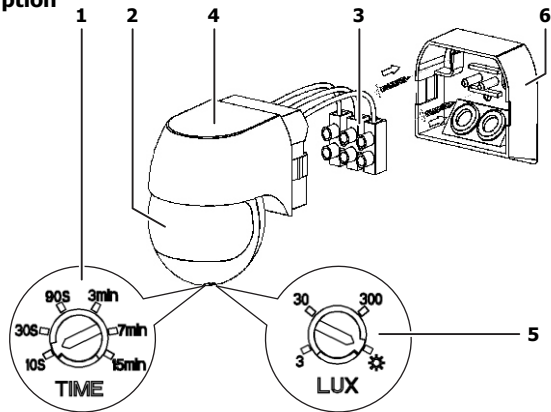

1. Time setting knob
2. 3LUX Sensor
3. Wire connection points
4. Sensor body
5. LUX setting knob
6. Back cover

## Function

### Can identify day and night:

The consumer can adjust the work ambient light. The sensor can work in the daytime and at night when it is adjusted on the "sun" position (max). It can work in the ambient light less than 3LUX when it is adjusted on the "3LUX" position (min). For more detail on the adjustment pattern, please refer to the testing pattern.

### Time-Delay is added continually:

When the sensor receives the second induction signal, after the first induction, it will compute the time once more on the time set of the first time-delay rest.

### Time-Delay is adjustable.

The sensor can be set according to the consumer's desire. The time can be set to 10sec, 30sec, 90sec, 3min, 7min & 15min ( $\pm$  2min).

## Testing Pattern

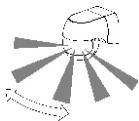

Good sensitivity

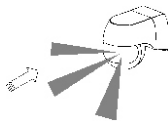

Poor sensitivity

## Installation Advice

**The detector responds to changes in temperature, therefore the following situations should be avoided:**

- Avoid pointing the detector towards objects with highly reflective surfaces, such as mirrors etc.
- Avoid mounting the detector near heat sources, such as heating vents, air conditioning units, lights etc.
- Avoid pointing the detector towards objects that may move in the wind, such as curtains, tall plants etc.

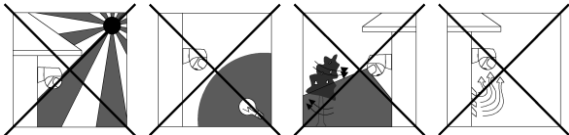

## Connection

- Loosen the screw in the back and remove the bottom (Figure 1)
- Connect the wiring according to the wiring diagram.
- Fix the back with inflated screw on the selected position. (Figure 2)
- Replace the sensor, tighten the screw and then test it.

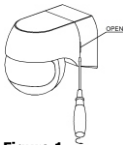

Figure 1

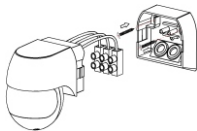
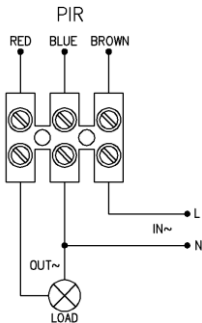

Figure 2

## Warning

- Danger of electric shock!
- Must be installed by professional electrician.
- Cover or shield any adjacent live components.
- Ensure device cannot be switched on.
- Ensure power supply is disconnected.

## Wiring Diagram



## Sensor Information

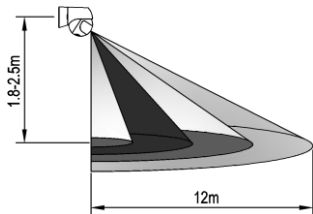

**Height of installation: 1.8-2.5m**

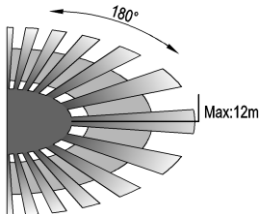

**Detection Distance: Max.12m**

## Testing the Sensor

- Turn the TIME knob anti-clockwise on the minimum (10s). Turn the LUX knob clockwise on the maximum (sun).
- Switch on the power; the sensor and its connected lamp will have no signal at the beginning. After 30sec warm-up, the sensor will start to work .If the sensor receives the induction signal, the lamp will turn on. While there is no another induction signal any more, the load should stop working within 10sec  $\pm$ 3sec and the lamp would turn off.
- Turn **LUX** knob anti-clockwise on the minimum (**3**). If the ambient light is more than **3LUX (daylight)**, the sensor will not work and the connected light will stop working too. If the ambient light is less than 3LUX (**night**), the sensor will work. Under no induction signal, the sensor should stop working within 10sec  $\pm$ 3sec.

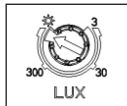
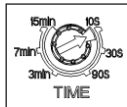



## Testing the Sensor continued

### Note:

When testing in daylight, please turn **LUX** knob to ☀  
(**SUN**) position, otherwise the sensor light will not work!

## Errors and Corrections

### The load does not work:

- a. Check if the connection of the power source and the load is correct.
- b. Check if the load is good.
- c. Check if the settings of working light correspond to ambient light.

### The sensitivity is poor:

- a. Check if there is any hindrance in front of the detector that affect the ability to receive the signals.
- b. Check if the ambient temperature is too high.
- c. Check if the induction signal source is in the detection field.
- d. Check if the installation height corresponds to the height required in the instruction.

## **Errors and Corrections continued**

### **The sensor can not shut off the load automatically:**

- a. Check if there is continual signal in the detection field.
- b. Check if the time delay is set to the maximum (15min) position.
- c. Please check if the power corresponds to the instruction.

## Specifications

Power source	220V ~ 240V/AC
Power Frequency	50Hz ~ 60Hz
Ambient Light	3, 30, 300, 2000 LUX (selectable)
Time delay	10s, 30s, 90s, 3min & 7min up to 15 minutes ( $\pm 2$ min) (selectable)
Rated Load	max: 800 Watts (incandescent lamps)
	max: 400 Watts (energy-saving lamps)
Detection Distance	12m max ( $< 24^{\circ}\text{C}$ )
Detection Range	180°
Working Temperature	-20°C ~ +40°C
Working Humidity	< 93% RH
Installation Height	1.8m ~ 2.5m
Power Consumption	$\pm 0.50\text{W}$
Detection Motion Speed	0.6 ~ 1.5m/s

# ***MAJOR TECH (PTY) LTD***

T9 Industrial Village, 7 Sam Green Road,  
Tunney Ext. 9, Elandsfontein,  
South Africa  
P.O. Box 888, Isando 1600,  
South Africa

National Contact Number: 08 61 62 5678  
E-mail: [sales@major-tech.com](mailto:sales@major-tech.com)

[www.major-tech.com](http://www.major-tech.com)

